



**Your  
Quality  
Confirmed.**

**Open Test Solutions**

**FIS**



# Table of Contents

Open Test Solutions . . . . .	1
ATM Test and Configuration Solutions	2
Bank Payment Testing . . . . .	4
Real-time Payments Test Solutions . . .	6
Host Test Solutions . . . . .	8
EMV Test Solutions, Services and Consulting . . . . .	10
Web-based Test Solutions . . . . .	12
Test Services . . . . .	14

[opentestsolutions@fisglobal.com](mailto:opentestsolutions@fisglobal.com)



# Open Test Solutions

## Enabling reliable payment solutions

Testing is a critical process in any enterprise environment. Especially in the payments industry, your brand reputation needs to be pristine. Moreover, going to market fast with the right payment solution can be challenging.

Open Test Solutions help you to save time and implement payment solutions that are adapted for the profound changes that the payment landscape is undergoing.

Reliable payment solutions, superior quality, innovation and a correct implementation of industry standards all rely on a good test strategy.

Open Test Solutions help you to virtualize your test environment and do more with less by implementing automated, continuous testing.

### Why choose FIS as your partner?

We are passionate about testing, but we find that the main reason our customers choose us — and keep coming back — is because we strive to establish a genuine long-term partner relationship. In 2015, 86% of our customers indicated that our test solutions bring a positive contribution to their daily job.

We listen to our customers, which enables us to generate the insights that we use to develop solutions that fit your business perfectly.

Rely on our 25 years of expertise...more than 500 companies already do.

### Test automation will save you time

Automated testing is the best way to increase effectiveness, efficiency and coverage of your payment testing.

An automated test solution allows multiple test executions with limited effort, comparison of the results with previous runs and generation of detailed log reports for analysis. Also, automation allows you to quickly react to unexpected issues or events that turn up in the final stages of testing.

It's an essential component of a successful project.

### Test virtualization: for a better coordination of development and testing

Using our virtualisation capabilities you can simulate any component of the payment chain that interfaces with your system. This approach avoids working with live systems which can be time-consuming, expensive or simply not available to you. Don't let this be a bottleneck ever again; develop, test, debug and test again.

### Reduce risk and cost, assure your quality

- FIS Test Tools run on a modular platform that allows your test environment to grow in sync with new technologies or revised rules.
- We give you the freedom to customize your tests, expand your test coverage and create test scenarios that fit your exact needs.
- All test tools are built on field-proven technology used and acknowledged by reference companies such as: Bancontact/MisterCash, Barclays, JCB, MasterCard, Visa, Pulse, Worldline, and WorldPay.
- To ensure you benefit from the newest developments, we work closely with industry bodies such as EMVCo, IFSF and the major payment brands.
- Open Test Solutions offers a compelling set of tools so you can prepare for certifications with confidence
- Identify risk areas, remove complexities and improve testing.
- Facilitate regression testing and go beyond the limits of manual testing.
- You can rely on our knowledge. We share our vision and our people with you.

# ATM test and configuration solutions

For: banks, ATM manufacturers, switch vendors, ATM service operators

Using an ATM is one of the most frequent interactions that customers have with their bank. It is important that their experience is a good one so you and your customers enjoy an immaculate brand reputation.

Take control of your ATM channel: automate your testing, minimize downtime and support innovation.

## ATM TestLab

ATM TestLab is our reference test solution for validating your ATM applications. Mitigate the risk of unexpected changes or defects that impact the availability of the ATM service.

Our test solution enables you to create a cloud of virtual ATMs, enabling remote teams to contribute to ATM software testing and to multiply the number of ATMs available, preventing scarce hardware from becoming a bottleneck.

Using test automation features, users can create and manage a central repository of test cases, resulting in better visibility of the ATM testing process across teams, regions and time-zones. The test repository becomes a valuable asset, and turns testing from a cost-centre into something that adds tangible value into the future.

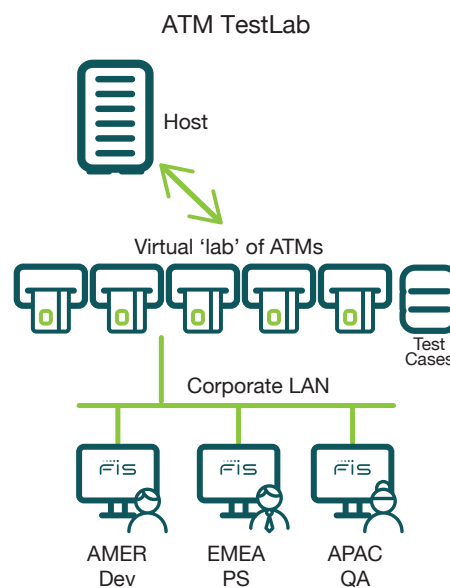

Take control over your  
ATMs: release changes  
easily and minimize  
downtime.

## ATM TestBench

ATM TestBench offers you powerful test automation capabilities for the ATMs in your lab, in a simple-to-install package. It is developed for banks or ATM operators with small test teams or minimal IT infrastructure.

If you don't require a virtualized or multi-user test solution but still want to make better use of the ATMs in your test lab, ATM TestBench gives you the competitive edge that delivers real business value.

## ATM Developer

Adding and changing content in the ATM network can really enhance a customer's ATM experience and the network owner's brand image. From seasonal messages on ATM screens to new transaction functionality, the ability to react quickly to customer demands and to take advantage of technological evolution is a key competitive differentiator for banks and processors.

ATM Developer is a solution that provides you easy-to-use editing of both screen content and logical transaction flow for 'states and screens' ATM protocols such as NDC or 912, giving you the ability to change configuration files quickly in response to business needs.

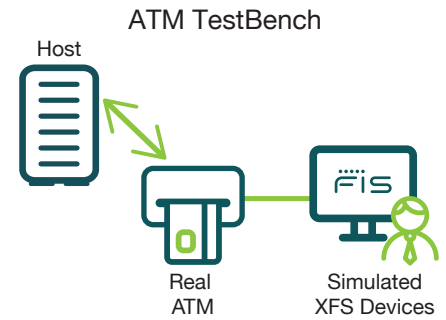

# Bank payment testing

For: financial institutions, processors, banks and corporations

The payment industry has grown increasingly complex: there are a multitude of channels, credentials and new technologies involved in the processing of batch files as well as real-time payments.

But how can you make all these components interact seamlessly?

Testing and identifying the risk areas within the multifaceted payment landscape will improve cost-effectiveness, accelerate time-to-market and ensure efficient payment hubs that exceed the requirements of today's diversified world.

## Product description

Customers gain access to banks and processors through a variety of channels, with each channel demanding its own specific processing. Retail clients, corporations, clearing houses and other banks, each present different transaction types containing clearing data, credit transfers, direct debits, etc. Moreover, the payment files are presented in multiple formats including plain text files, XML files or even reports in a proprietary format.

Payment systems must be capable to process incoming payments and generate incoming and outgoing output files that must be routed over more interfaces, according to specific business rules. The operational efficiency in performing this file transfer authority role is a key aspect of the operation.

Testing this complex infrastructure has become indispensable. Therefore, you can rely on a specific set of solutions for optimising your payment testing process:

## Payment file generation

Verify that the payment hub is capable of processing payments and check if these are validated correctly.



## Payment file validation

Verify if the payment hub correctly generates payment files



## Crosschecking of input and output files

Verify if the payment hub correctly generates output files. In some cases it is not the output file generation that is to be tested but the corresponding actions that are taken during processing, for example, updating internal databases. The Test Solution can easily replicate the complex configurations/environments, including the multiple channels and multiple formats.

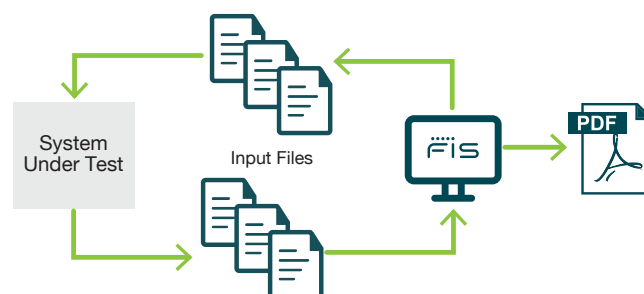

## Simulating

Our test tools enable the simulation of payment schemes, clearing houses, enterprises and bank systems.







# Real-time payments test solutions

For: financial institutions, processors, payment solution providers and clearing houses

Around the world, banks, payment providers and clearing houses are implementing faster payment systems to cope with changing market demands.

Handle real time payments efficiently and reduce complexities. We help you optimize your investment.

Faster payments are a strategic element for financial institutions alike but will equally provide operational efficiency and better security among other benefits. Big, small or medium-sized companies have different goals and other needs. Do you aim to modernize your complete payment system? Are you going for an update of your legacy system? There's different strategies and approaches, also, each overhaul project has its particular hurdles to get over.

## Product description

Payment systems need to manage instantaneous transaction processing, process feedback and have to interface with both existing back-end systems and new API's. All while adhering to complex business rules.

The operational efficiency in performing this file transfer authority role is a key aspect of your instant payment plan. Our automated test solutions and methodology will help you achieve just that. You can bank on our +20 years of payments testing expertise acquired by working in a very similar, fast-paced environment — card payments.

## Product functionalities

### Payment generation

Enables you to verify if your systems are capable of receiving/processing payments and check if the data is validated correctly.

### Payment validation

Validate a correct generation of payments.

### Crosscheck of payments, incoming and outgoing

Test whether your systems correctly generate payments. In some cases it is not the payment that is to be tested but the corresponding actions that are taken during processing, for example, updating internal databases, exchanging information across different internal systems (e.g. core system, payments execution engine, accounting systems). The Test Solution can easily replicate the complex configurations/environments, including the multiple channels and multiple formats.

## Virtualisation (or simulation)

A payment project consists of different complex functionalities with multiple connected components that must be tested. Create an efficient test environment by emulating the missing elements or elements that are scarce or expensive such as banks, clearing houses, corporates. Decrease costs, improve productivity and your quality.

## Test case and test data management

We offer you business-oriented solutions with separately stored Test Data Management to avoid repetitive capture of originators or beneficiaries. During test case generation, testers can simply refer to the data that you control and test cases will update automatically when data changes. Users can easily create, manage, execute and maintain test cases or regression test sets.



Launch with confidence, go faster-to-market  
and control your costs.

Sample real-time payments scenario

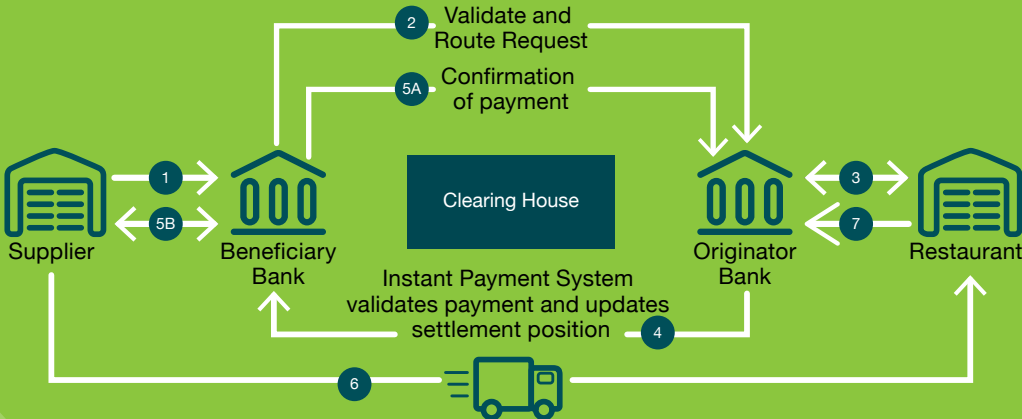

Sample test environment

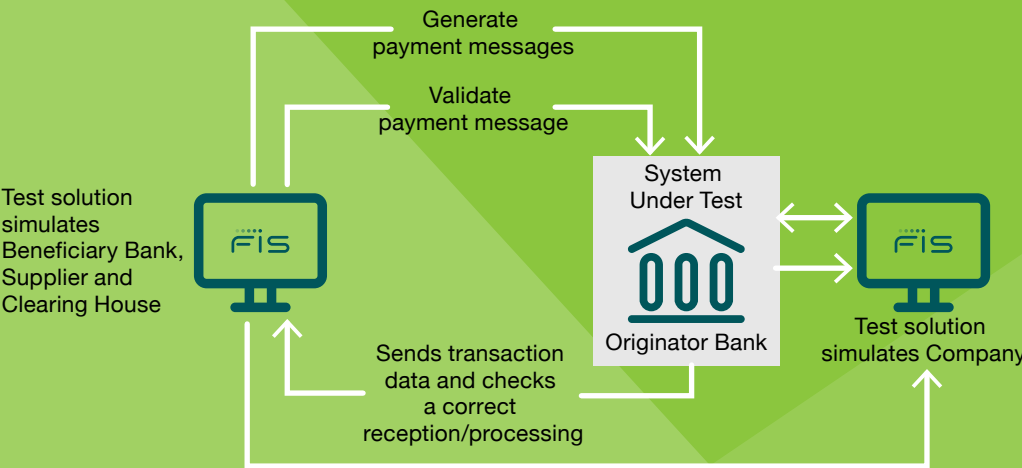

# Host test solutions

For: acquiring and issuing banks, processors, payment networks and merchants

FIS's automated test solutions help you to save time and facilitate regression testing with limited manipulation, providing you a substantial return on your investment.

Almost every card payment transaction using a debit or credit card at a Point-of-Sale terminal, ATM or online shop results in a real-time authorisation request message that travels through the payment network to the Issuer. The Issuer accepts or declines the transaction and sends a response message. Most payment network owners require acquirers and issuers to pass certification tests before connecting. The ISO 8583-based format specifications created and owned by payment brands are constantly evolving with changes in business requirements and technological evolutions. With each update, your system needs to be retested on new functionalities and regression.

The FIS Host Test Solutions validate your system through the existing authorisation interfaces. We provide

you dedicated solutions, depending on your role in the card payment ecosystem.

## Functional testing

The payment network specifications cover many aspects, including format of exchanged messages, transaction behaviour, and authorization rules.

Our Host Test Solutions suite of products helps you ensure that these specifications are correctly implemented and exclude any major disorder in your payment infrastructure. Using our virtualisation capabilities you can simulate any component of the payment chain that interfaces with your system. This approach avoids working with live systems which can be time-consuming, expensive or simply not available to you.

Advanced automation features enable you to run your tests over and over again with minimal effort. Moreover, your test coverage can be expanded far beyond the limits of manual testing: imagine the increase of productivity, cost-reduction and tester-fatigue prevention.

The FIS suite of automated test solutions include simulators for each of the different components in a payment system, pre-defined test scenarios, comprehensive log and report features and detailed error analysis capabilities.

Example test configuration: acquirer testing by enabling simulated messages coming from a payment terminal and network/issuer virtualisation simulating all possible responses.

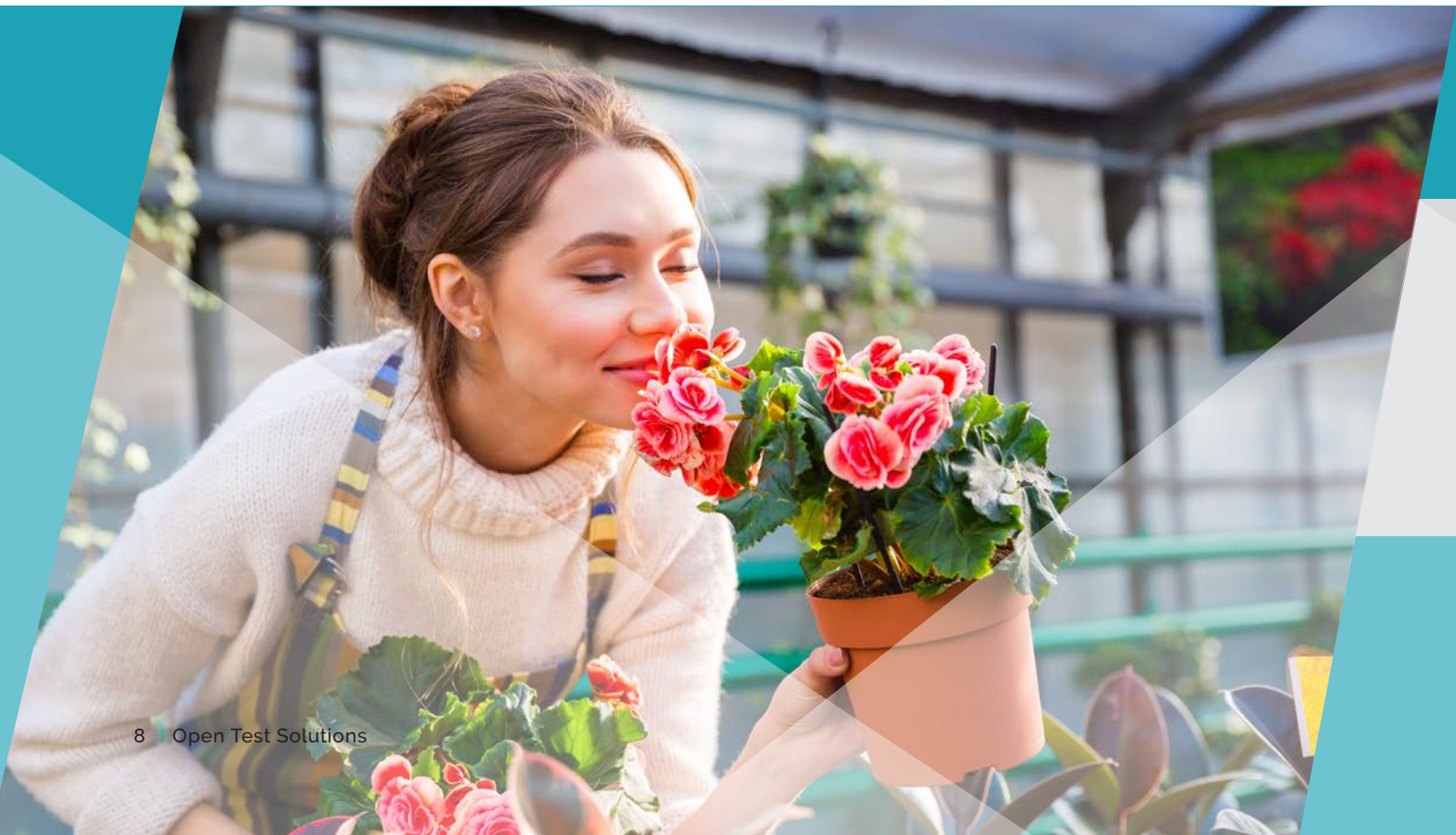



## Clearing and Settlement

The Clearing and Settlement mechanism is difficult to test and necessitates a wide test scope. Also, after every release of new specifications or upgrade you need to revalidate a proper functioning of your payment system.

Our automated test solutions help you to save time and facilitate repeatable testing with limited manipulation, providing you a substantial return on your investment.

Our Clearing and Settlement Test Solutions help you verify the behaviour of an issuer or an acquirer on the clearing and settlement interface in an automated way. This includes the creation of the Clearing and Settlement data — based on

real authorisation messages — and validation of clearing and settlement messages.

The validation of the messages typically consists of:

- Validation at file level
- Validation at Record level
- Cross-validation of data in related records
- Lifecycle tests

The Inbound File generation will create test files:

- Containing valid data
- Containing invalid data (syntax errors, invalid file structures, semantic errors,...)

## Capacity testing

Imagine a payment system that fails during peak shopping times. This will cause revenue loss and damage your brand reputation. Our stress test solution enables you to analyse specific areas of your payment system and identify and solve potential system bottlenecks or application overloads... for a reliable system and a satisfying customer experience.

Our tools drive transactions at a defined rate (transactions per second) and act as the acquirer, payment network or issuer to isolate the system under test.

Capacity testing can be done during different phases of your software development life cycle: new implementations, maintenance, major upgrades or during mergers and acquisitions.

## Streamline your cloud-based payment implementations

**Example test configuration:** acquirer testing by enabling simulated messages coming from a payment terminal and network/ issuer virtualisation simulating all possible responses.

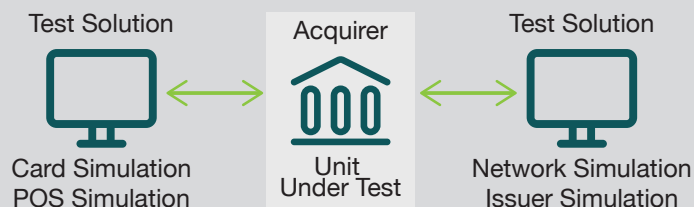

# EMV test solutions, services and consulting

For: acquiring and issuing banks, VARs, processors and merchants



Let 25 years of expertise help you define your unique route to EMV

Overcome complexities | Meet deadlines | Cut costs

## EMV Terminal Integration Test Solutions

When deploying your card payment devices, you need to ensure these are tested and certified according to brand requirements and EMVCo specifications.

This can be a complex and time-consuming task, especially if you test manually. Open Test Solutions for Terminal-Acquirer Integration are developed to simplify your move to EMV and ensure the correct integration of terminal and acquirer; the tools can be used during pre-certification and brand certification processes. Automation makes certain that you and your staff's valuable time is being utilised in the most optimal way.

Used during both the pre-certification and brand certification processes, these test solutions are the essential toolkit to ensure a successful integration of EMV terminals in the acceptance environment.

## EMV Terminal Integration Services

Compliance to the governing EMV regulations is challenging and getting it wrong is not an option; this could have a serious impact on your brand reputation.

Our long history in payments and EMV technology helps you navigate through EMV complexities and maximize your investment. We work closely with industry organizations, such as EMVCo, and both domestic and international payment brands. You can be sure you are always on top of the latest evolutions.

Acquirer and processor EMV readiness is a critical part in any EMV project. It is generally considered as one of the high risk areas. You must comply with the payment network rules and requirements and demonstrate the ability to process EMV data and route authorization messages for EMV transactions. Each payment network has defined a specific set of tests that must be passed before allowing the terminals to be deployed in the production environment supporting the payment network's EMV products.

Our team of seasoned experts can assist you with all your certification needs.

## Pre-certification

A successful pre-certification process will enable you to prepare your environment in the most optimal conditions and resolve issues quickly, enabling a fast and successful go-to-market and facilitating a smoother and compliant formal brand certification.

Our experts help you streamline your project time frame, either on your premises or off-site in our certification laboratory. Our holistic approach allows you to benefit from both tooling (see section on test solutions) and the set-up of the entire pre-certification process.

We have worked on flexible collaboration models with the payment brands. Within all current business models, we strive to act as a strong and reliable partner — resulting in a win-win model for both companies.

A typical example of our pre-certification services includes:

- Setting up the test environment
- Accredited test solutions
- Test execution
- Technical Support
- Log Analysis
- Validation report

## Formal brand certification

This service will be a follow-up step to the pre-certification process. During the brand certification phase, the acceptance environment of a merchant in conjunction with an acquirer or processor is tested.





In addition to the pre-certification process, we take you through the entire certification procedure, managing all formalities such as communication with the acquirer/processor and payment networks. Our teams will work with you on registration of the product and validation of the environment against the payment brand product requirements. Technical experts evaluate test results against the payment network and acquirer or processor requirements. A detailed test analysis report, including authorization logs and card-terminal traces, will be provided. In case of required iterations, our experts will assess and take the essential steps for improvement and issue resolution.

Based upon the test analysis report, we then go through the full approval steps as required by each Payment Brand.

### Training

Understand the fundamentals of payments and the standards of the card industry. Our trainers will guide you through every aspect of EMV specifications and how they are implemented as smart card credit and

debit products by the major payment brands. The courses also clarify which steps you need to take to implement EMV in issuing and acquiring domains. We will also look at the impact these steps have into the emerging area of contactless payments, mobile, transport, pre-authorized and others.

We can complement this EMV training with a scoping workshop to identify a high-level implementation plan and resource requirements. Together, we take a deeper look into what needs to be done and the capabilities required. The output is a high-level project plan and a gap analysis report.

### Consulting

Unlocking the power of EMV can be a challenge. Faced with the pressures of deadlines, risks, certifications, costs, customer experience and technical challenges, where do you begin? And what comes next? With FIS as your partner, we'll show you precisely what you need to do, and when. We'll help you understand your new responsibilities, opportunities and guide you towards a winning strategy.

Whether your EMV project is in the starting blocks or in full swing, we provide on-site resources for project management, test planning and execution. We assist you with a tailored approach at all levels. Combining business and technical knowledge with advisory services and analysis capabilities, our team enables smooth project coordination and tightly controlled governance.

A few examples of how we support you:

- EMV migration infrastructure readiness evaluation
- EMV migration impact and process gap analysis
- Compliance assessment, certification analysis, testing requirements and test tools advice
- Migration strategy evaluation
- Process development recommendation
- Organisational process governance
- Steering committee process support
- Subject matter expertise support

Unlock the power of EMV, with FIS as your partner.

# Web-based test solutions

For: banks, merchants, processors and terminal vendors

---

Testing of payment systems and payment devices is customarily done with the test software installed locally on a PC. This limits the many features to a single user at a time. Browser-based testing brings a new dimension to organising industry conformance validations and ensuring the quality of your payment solutions. It unites the accessibility of the cloud with full control over executed test scenarios, cost-effectively.

## Product description

This cloud-based test solution allows multiple users to simultaneously use the tool's functions, wherever the users are located. Users can consult test results remotely, making monitoring and analysing easier and more effective.

Today's payments test solutions are predominantly desktop-based. The FIS web-based test platform introduces a web interface and database that enables execution and storage of test artefacts like traces, verdicts and reports, which can easily be shared between internal and external users. Typically, external users only see their own results whilst internal users can monitor all results.

The web-based test solution complements a desktop test application and expands its capabilities.

## Accelerate your (pre-) certification cycles:

- Execute tests automatically and avoid manually assigning test environments before each test session.
- Initiate transactions via a web browser to test the behaviour of a payment system.
- Reduce the need for fixed time slots.
- Exercise your subset of test scenarios and gather the results in one place to make submission to certification bodies easier.
- Improve the visibility of your certification testing progress.
- Simplify your monitoring and exporting of test reports to analyse test cases.

## Make your testing more productive:

- Simplify your testing — Remote users get access to a simulated host or network test environment via the web.
- Respond to transactions to verify if your payment components react as defined in test scenarios.
- Turn testing from a cost centre into a profit centre.
- Reduce administrative overhead and virtually multiply your test resources.
- Optimize your investment — Access a wide range of accredited simulators to perform certification tests without staff intervention for most major payment networks (and proprietary test plans).
- Harmonize testing within your team(s) and remove geographical restrictions.
- Ease the onboarding of new customers.





Online verification of your payment applications for more control and scalability. Centralise the management of your test environment and increase productivity of your QA resources.

### Example — A web-based test environment built for a large U.S. payment processor

When one of the largest processors in the U.S. asked us to develop an integrated and automated test platform to ease their customer's terminal onboarding to EMV, we carefully analysed their needs and developed a web-based test environment that facilitates a seamless payment brand certification cycle.

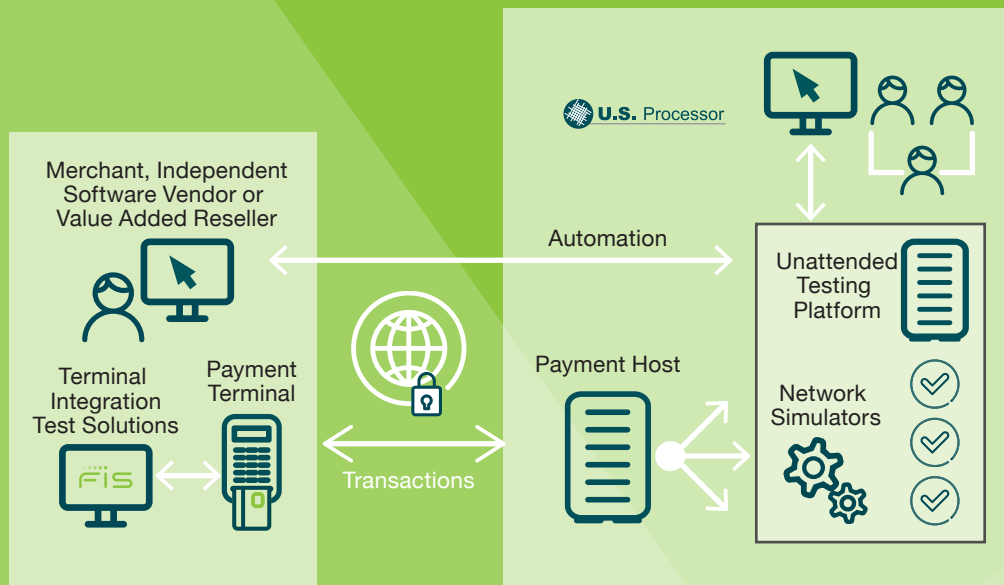

An automated desktop test suite connects to the "onboarding" customer's terminal (under test). Test scenarios, as defined by the payment brand(s), are sent to the processor's payment system to verify its behaviour. End-users at the processor and their customers can remotely monitor test results.

# Test services

For: financial institutions, processors, merchants, banks and corporations

We provide the services that help you tackle the challenges of the payment world. For decades, we have been the partner of choice for banks, payment processors, payment networks and service providers. We take care of your testing and certification needs, making your projects lighter and optimizing your investments.

## Certification services

It is not always possible to master the ins and outs of the payments industry. It's often a balancing act between international standards, the international or domestic payment brands and the newest technologies. You might not have the bandwidth to cope with all the mandatory requirements or maybe you just want to stick to your core business.

Our Certification Services help you to comply with the standards and requirements set by domestic payment brands, international card brands or organisations such as EMVCo.

FIS can also help you set up your in-house test laboratory or do the certification of your suppliers/partners/members' products on your behalf. We support you in defining your certification processes and test environment, test execution, analysis, validation, reporting and advice towards the brands or industry body. A fully administered test laboratory can be completely tailored to your specific needs.

See page 10 for EMV Terminal Integration Certification Services

## Test optimisation services Automation

Automated testing is the best way to increase effectiveness, efficiency and coverage of your payment testing. An automated test solution allows multiple test executions with limited efforts, compare the results with previous runs and generate detailed log reports for analysis.

It's an essential component of a successful project: let our test experts assist you in setting up a fully automated test environment.

## Testing as a Service (TaaS)

Testing a payment system is complex: integration points, data to prepare, different message formats, changing rulebooks and lots of configuration required to trigger specific scenarios. Moreover, qualified test resources are hard to find.

TaaS combines a test software solution with a completely integrated business solution. It allows a unique mix of:

- An automated test solution for diversified applications and changing environments
- Business capabilities
- Technical knowledge

We provide you with both the software and a professional consultant/tester, offering you a significant return on investment within the first year of implementation.

## Test Environment Assessment (TEA)

An important factor for delivering a high quality system is an optimised test process. Our consultants can support you with an in-depth analysis of current test infrastructure, whereby they will verify the correctness and completeness. A detailed TEA-report will be delivered that will include recommendations for an optimal environment, test automation and a mature test methodology.

## Tool customisation

If you're looking for a test solution that matches your exact requirements, we can customise an existing off-the-shelf product. We can build the test solution that only exists in your mind.

## Outsourced testing

If you don't have the time or the knowledge, or just want to focus on your core business, you can count on our test experts either on-site or in our laboratory.

We make sure each system or device is tested both from a functional and from a performance perspective. We take care of your test plan, test definition, test implementation, test execution and analysis. Acting like a partner, we can blend into your organisation as your QA-team in the software development life cycle.

We share our knowledge, our vision and our people with you



**Your  
Quality  
Confirmed.**

[opentestsolutions@fisglobal.com](mailto:opentestsolutions@fisglobal.com)



## About Open Test Solutions

Open Test Solutions is an expert provider of test solutions and test services for all electronic payment transactions.

We help our customers save time and efficiently launch payment innovations that meet the highest quality standards. From a leadership position, we aim to build a true partner relationship to build engagement and generate insights that we use to develop the solution that fits your business perfectly.

FIS is the world's largest global provider dedicated to banking and payments technologies. FIS serves more than 20,000 institutions in over 130 countries.

# Your Quality Confirmed.

**OPEN TEST SOLUTIONS**



[www.fisglobal.com](http://www.fisglobal.com)



[opentestsolutions@fisglobal.com](mailto:opentestsolutions@fisglobal.com)

### Headquarters

De Kleetlaan 6A | B-1831 Diegem (Brussels) | Belgium

T: +32 2 402 52 00 | F: +32 2 402 52 01